

2 Zone Time Clock

User Guide UFHTIME2B

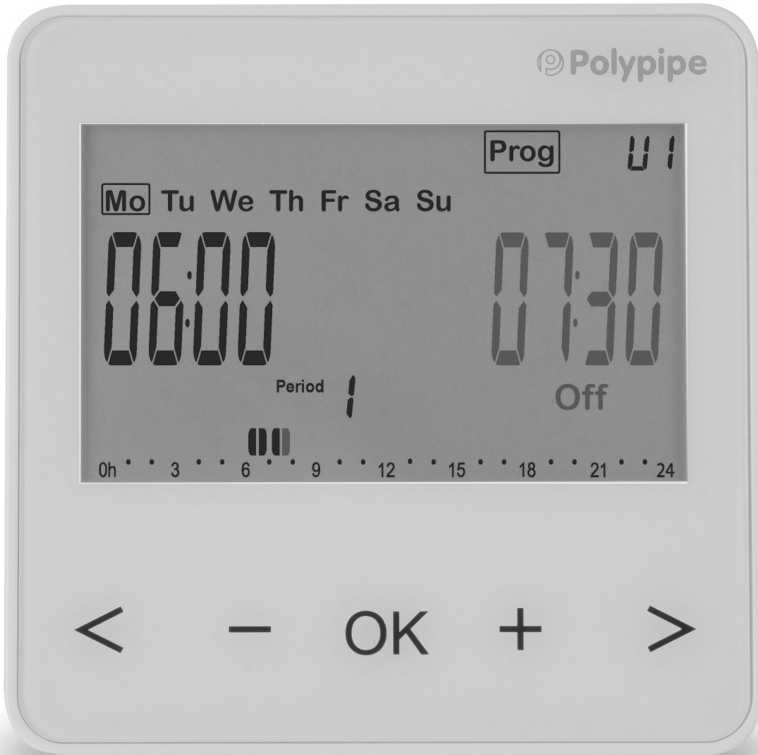

Overview

The 2 Zone Time Clock is designed to work with the Dial Thermostat (UFHDIALB) to provide time control per manifold. Time clock also has 1 other zone which can be used.

The unit is designed to be used with our range of wired master wiring centres and slave units.

This user guide provides user settings and Programming details, these and the advanced settings can also be downloaded from **www.polypipeufh.com** in A4 format.

Please Read Before Programming Your Time Clock

Time settings

The Time Clock operates in 2 different modes:



Comfort - The time clock is on allowing individual room thermostats to operate.



Setback - The time clock will be off, meaning no room thermostats will operate.

This is to assist the response time of the heating system.

Contents

- 1** Battery Access and User Controls
 - 1.1** Keyboard
 - 1.2** Display
- 2** First Time Installation
 - 2.1** Installing Batteries
 - 2.2** Time and Date Adjustment
 - 2.3** Zone Allocation
- 3** Selecting a Pre-set Program P1 - P9
- 4** User Defined Programs U1 - U4
 - 4.1** Creating User Defined Program

Contents

- 5** Operating Menus
 - 5.1** Automatic Mode
 - 5.2** Off Mode
 - 5.3** Holiday Mode
 - 5.4** Keyboard Lock Function
- 6** Pre-set Programs
- 7** Hidden Menus
- 8** Technical Specification
- 9** Fault Diagnostic

1 Battery Access and User Controls

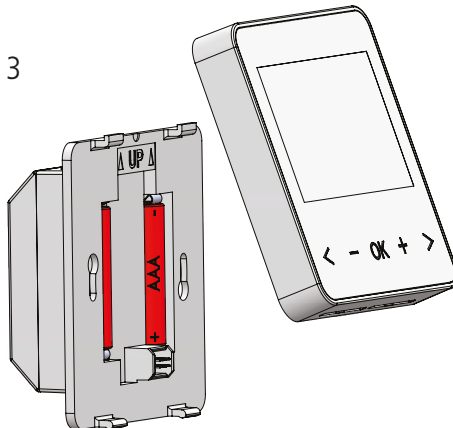
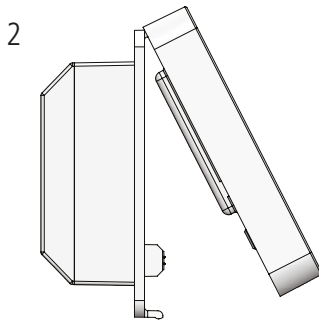
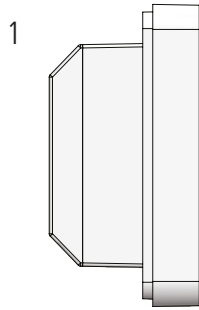

1.1 Keyboard

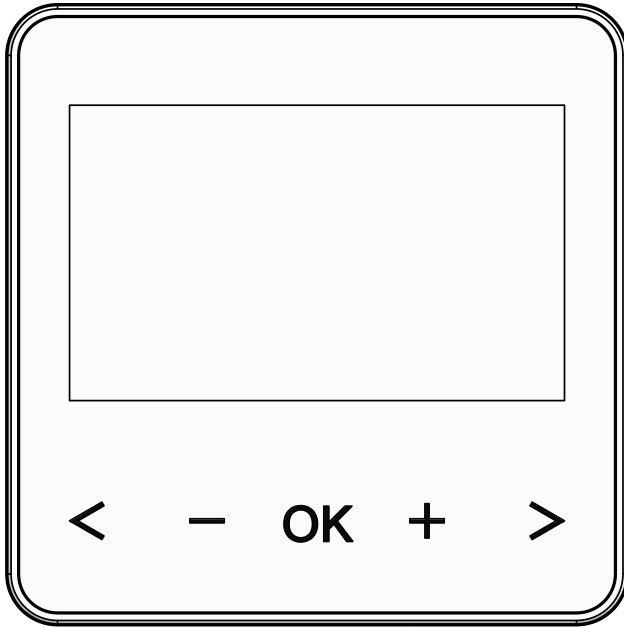

1.2 Display

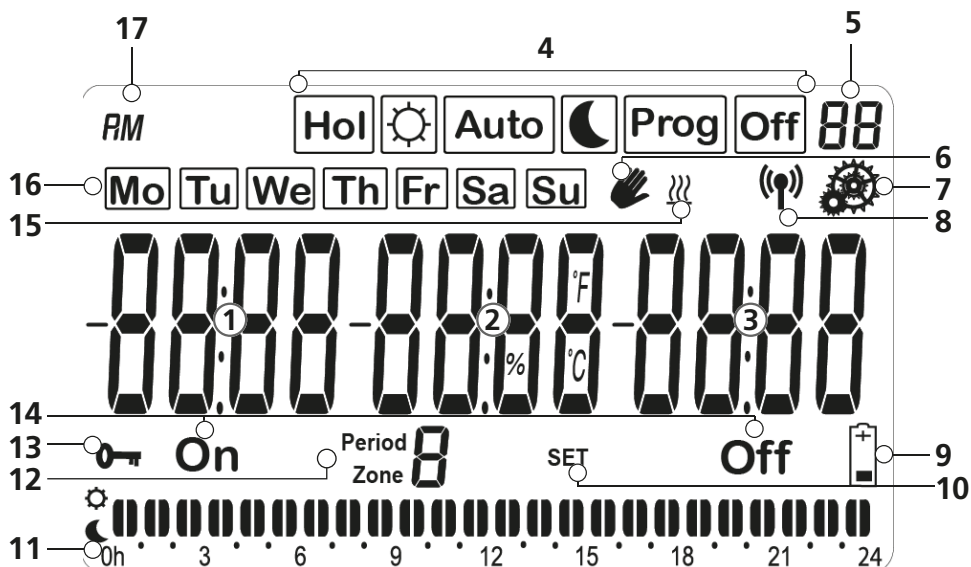

- 1-3** Setting or measured hour/text/indications
- 4** Operating mode menu
(active mode is framed)
- 5** Program number or parameter number
if "7" is displayed
- 6** Temporary override function activated
- 7** Installation parameter menu
- 8** RF transmission logo
- 9** Low batteries indicator
- 10** Modification of parameter
- 11** Program of the current day
- 12** Zone number or Period number in the
program of the current day or current
zone number
- 13** Key lock indicator
- 14** Current zone state: "On" (activated) and
"Off" (disabled)
- 15** Frost protection is activated
- 16** Days of the week (current day is framed)
- 17** AM/PM

NOTE: At any time, when the backlight is switched off, press the **(OK)** key to activate the backlight and wake up the product. Press another time the **(OK)** key to show the current setting temperature.

2 First Time Installation

This section will guide you to starting your time clock for the first time.

2.1 Installing Batteries

- Lift the front panel off and insert the 2 x AAA alkaline batteries supplied (or remove the small protection sticker if the batteries are already installed in the compartment)
- Replace the front panel
- Your time clock will ask you to set the time
- **Note:** The time and date setting can be set at any time by pressing the **(OK)** key for 3 seconds

2.2 Time and Date Adjustment

The value to be adjusted will blink, and is adjusted with keys **(-)** and **(+)**. Once the adjustment is made, accept it with the **(OK)** key.

The time clock will jump automatically to the next value.

Progress of the adjustments:

Time and day:

Hours setting

Minutes setting

Day of week setting

Date:

Day setting

Month setting

Year setting

You can access the time and date adjustment made by pressing **(OK)** key for 3 seconds at any time in off mode.

2.3 Zone Allocation

Once the time and date have been entered, the unit will ask you to activate the required number of heating zones by displaying:

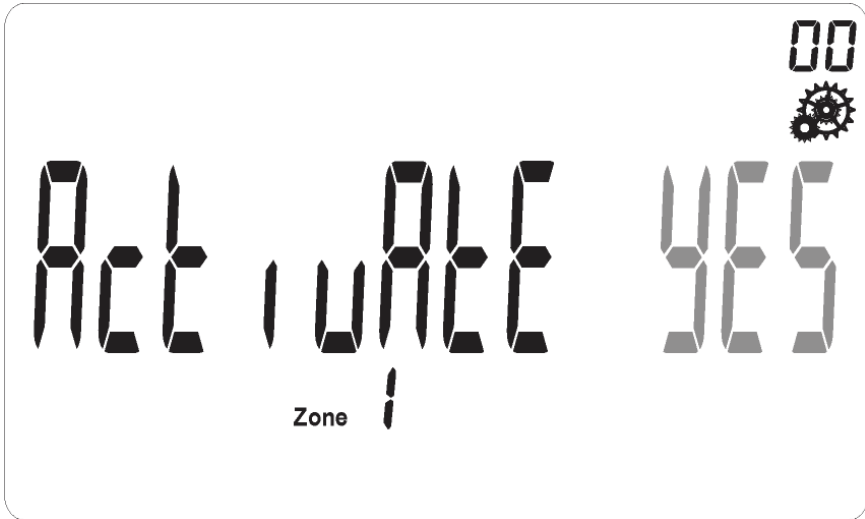

By displaying a flashing “Yes”, this means that Zone 1 is active. By displaying a flashing “No”, this means that Zone 1 isn’t active. Select “Yes” or “No” with **(-)** and **(+)** keys.

By pressing the < or > keys, select the zone number and if you want to finish zone initiation step, press **(OK)** key when this screen is displaying:

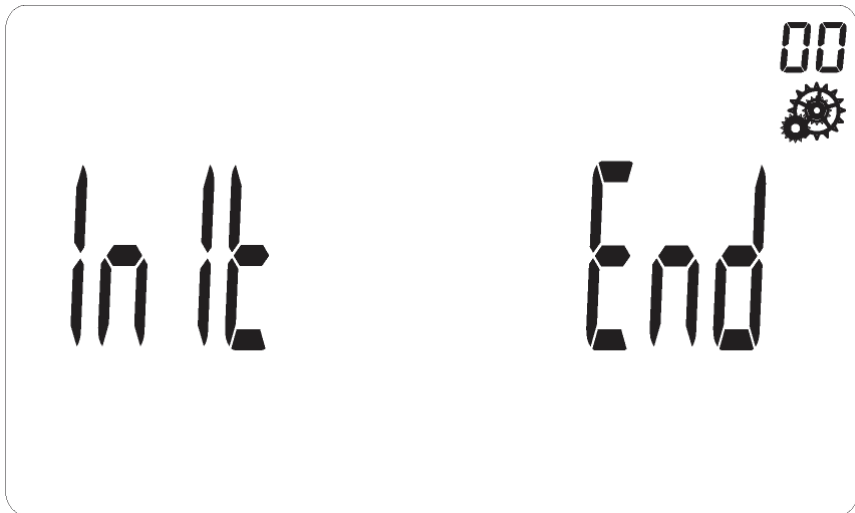

You will be able to change your configuration by accessing the zone activation menu (page 36).

Important: If no zone is activated, all working modes won't work.

3 Selecting a Preset Program P1 to P9

There are 9 preset programs **P1-P9**.

The time clock will default to **P1**
(see programs pages 26 to 34).

To select a preset program use the navigation keys to move the cursor from **Auto** to **Prog**.

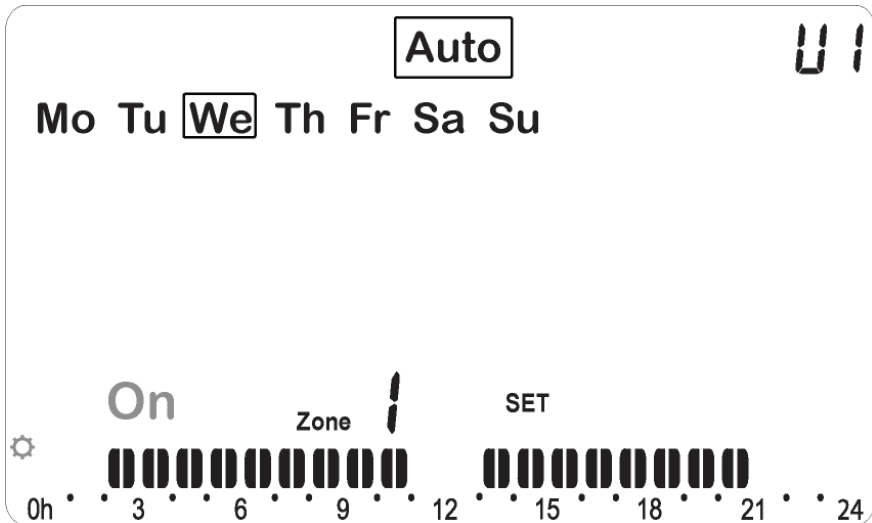

Press **OK** to make the P1/P9 adjustable.

Use the **(-)** or **(+)** keys to choose **P1** to **P9**,
or **U1** to **U4** (User Defined Programs).

Select and validate with **(OK)** to return to **Auto**.

4 User Defined Programs U1 to U4

You set "on" and "off" times for each period, you can define more than 3 periods per day eg. Morning, afternoon and evening. Between time periods, temperature will default to "Setback".

If for example at a weekend you only need your heating to come "on" and "off" once, you only need to set period 1 and skip the others. 

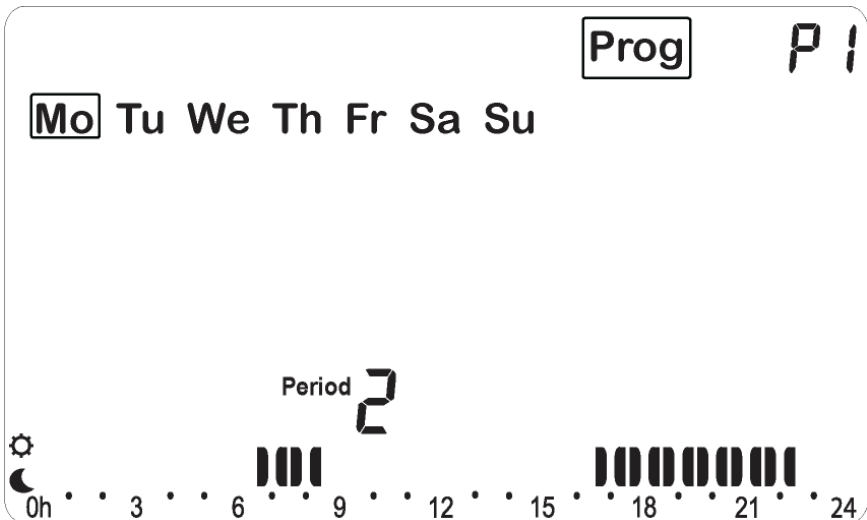

4.1 Creating User Defined Programs

Use the navigation keys to move from **Auto** to **Prog** as previous. Press **(OK)** to make **P1/P9** adjustable.

Use the **(-)** or **(+)** keys to choose **P1** to **P9**, or **U1** to **U4**.

Select any of **U1** to **U4** as this allows each time clock to store up to 4 user defined programs in its memory.

With **U1** to **U4** blinking press the **(OK)** key to access the program settings.

- The program creation will always start with the Monday.

Once you have pressed the **(OK)** key, the following display will appear:

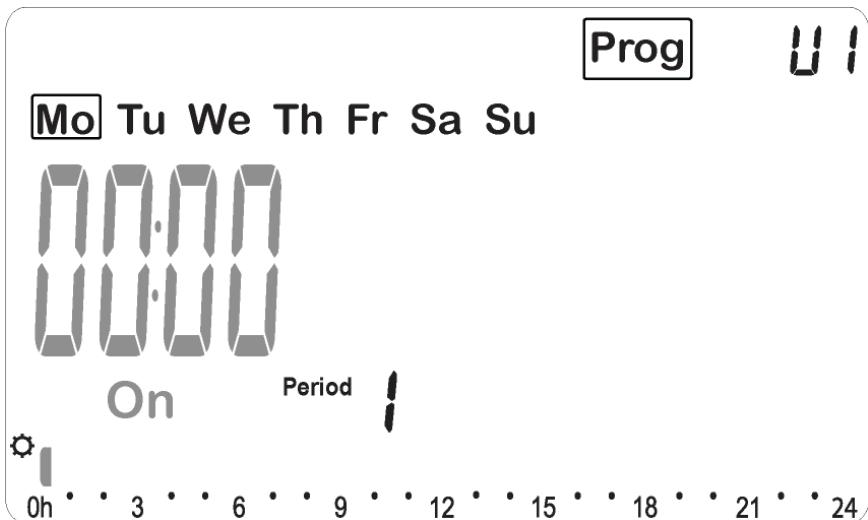

Adjust the hour of the first step of the program with **(-)** or **(+)**.

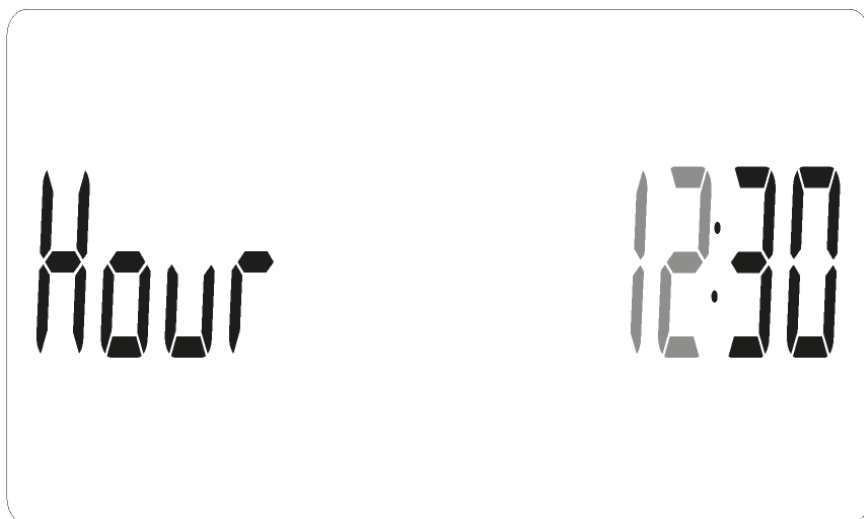

Press **(OK)** to validate and jump to the following step.

You can set this period to run to the end of the day (midnight) by pressing **(OK)** or, use the **(+)** button to set the "off" time for this period.

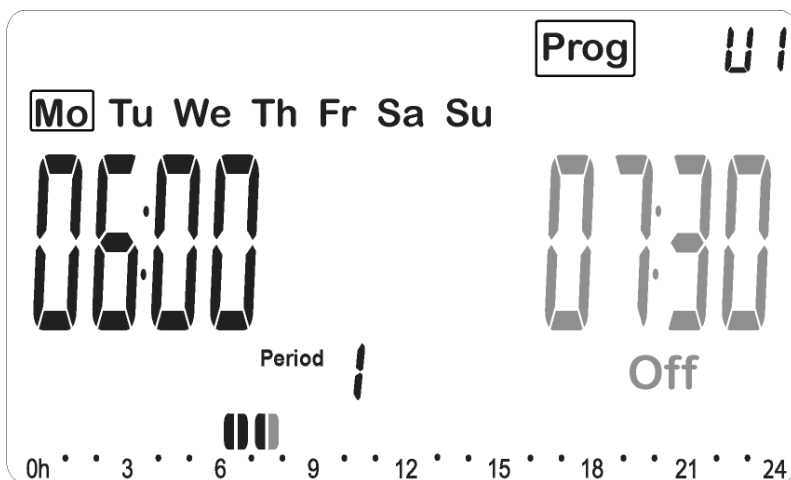

You will then see the below screen

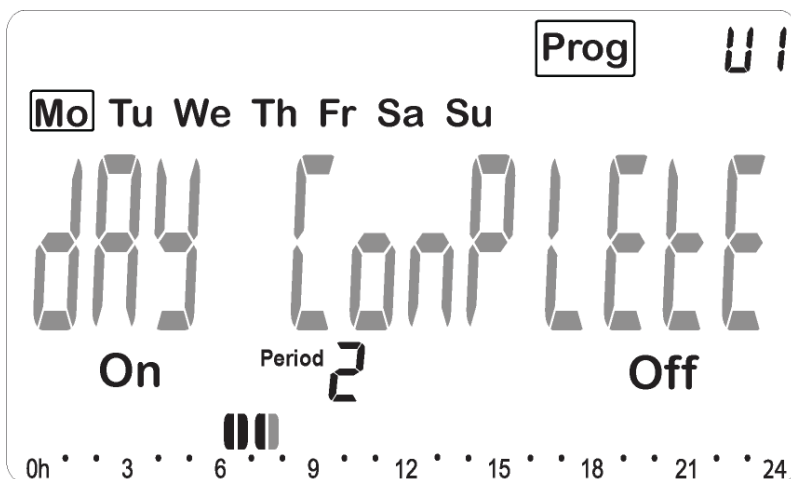

If all periods for this day are finished press **(OK)** to accept or press **(+)** button to set the start time for the next period.

Repeat previous steps until all periods are set and press **(OK)** to complete.

You then have the option to copy this period to other days, or create new programmes for each day.



You can scroll between "Yes" and "No" using the **(+)** and **(-)** keys. Pressing the **(OK)** button will accept your selection. You can copy to each day individually or scroll to "No" and create new programmes as previously.

To edit an existing user defined programme, select the existing programme in the **Prog** menu (U1 - U4) and press **(OK)** button. You will then be given the option "Edit Prog" "Yes" or "No"

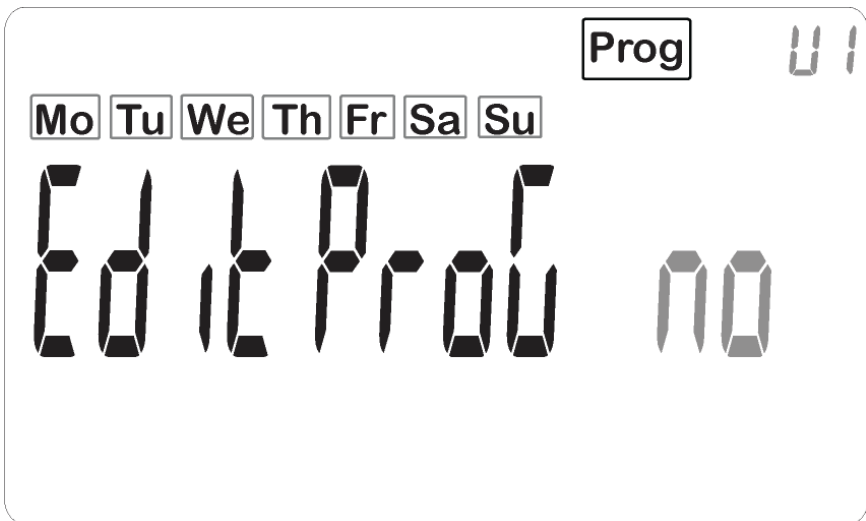

Selecting "No" will take you back to **AUTO** mode, selecting "Yes" will give you the option to erase "Yes" or "No". Selecting "Yes" will clear the previous programme and allow you to start from the beginning. Selecting "No" will allow you to edit the existing programme, scroll through days with the (-) or (+) key, then press **(OK)** on the day you wish to edit. Once complete, press **(OK)** to accept the programme and return to **AUTO** mode.

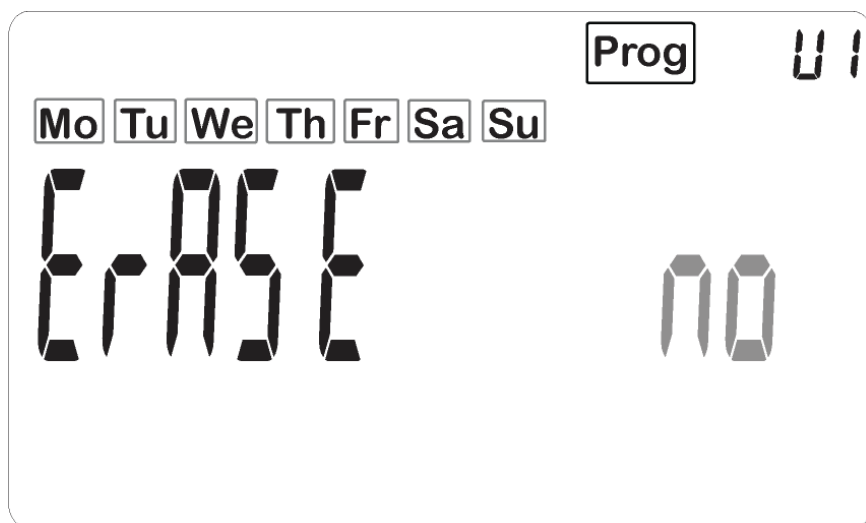

5 Operating Menus

5.1 Automatic Mode (Auto)

In this mode the time clock will follow the chosen program (Built-in or User defined) according to the time settings.

You can easily view the current operation of the other zones by pressing the (-) and (+) in Auto mode at any time.

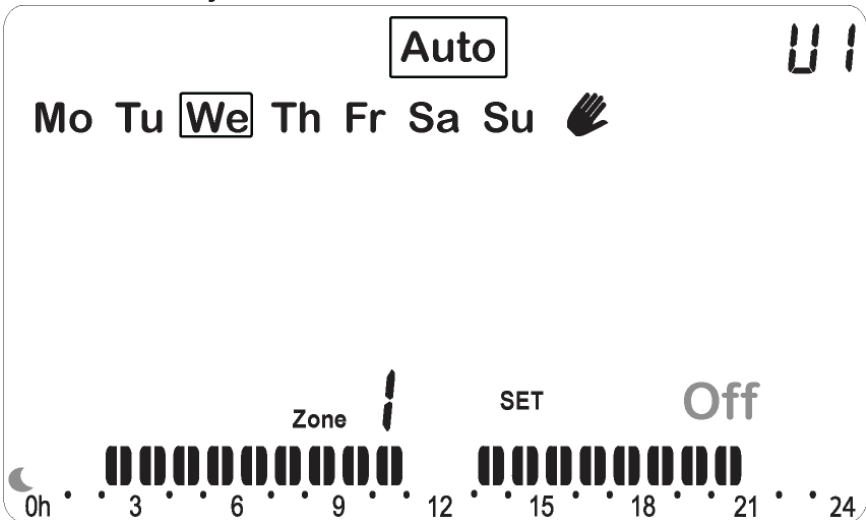

To manually override the schedule settings temporarily press (OK) and use (-) and (+) keys to toggle between 'off' and 'on' modes, press (OK) to confirm. If overriding the (Hand) symbol will be displayed. The set schedule will return at the next period change.

5.2 Off Mode (Off)

Use this mode if you wish to turn off your time clock.

Frost protection is automatically provided as a minimum temperature of 5.0°C will be maintained.

(This temperature can be changed, contact your installer or check advanced menu).

5.3 Holiday Mode (Hol)

The Holiday mode allows you to adjust the time clock for a period of days:

The display will show "no" press **(OK)**

- adjust the duration in hours with **(-)** or **(+)** press **(OK)** to validate.
- adjust the duration in days with **(-)** or **(+)** press **(OK)** to validate (adjustable 1 to 99 days).

The **(On)** icon will blink and the number of days remaining is displayed until the end of the period.

If you want to stop the holiday function before the end of the duration adjust the day period to 0 and scroll across back to **Auto**.

5.4 Keyboard Lock Function

Use this function to prevent changes to the settings:

- To activate the key lock function, press the two arrow keys simultaneously.
- The  logo will now be displayed on the screen.
- Repeat with the same procedure to unlock the keyboard.

6 Pre-set Programs

P1 Morning, Evening & Weekend



P2 Morning, Midday, Evening & Weekend

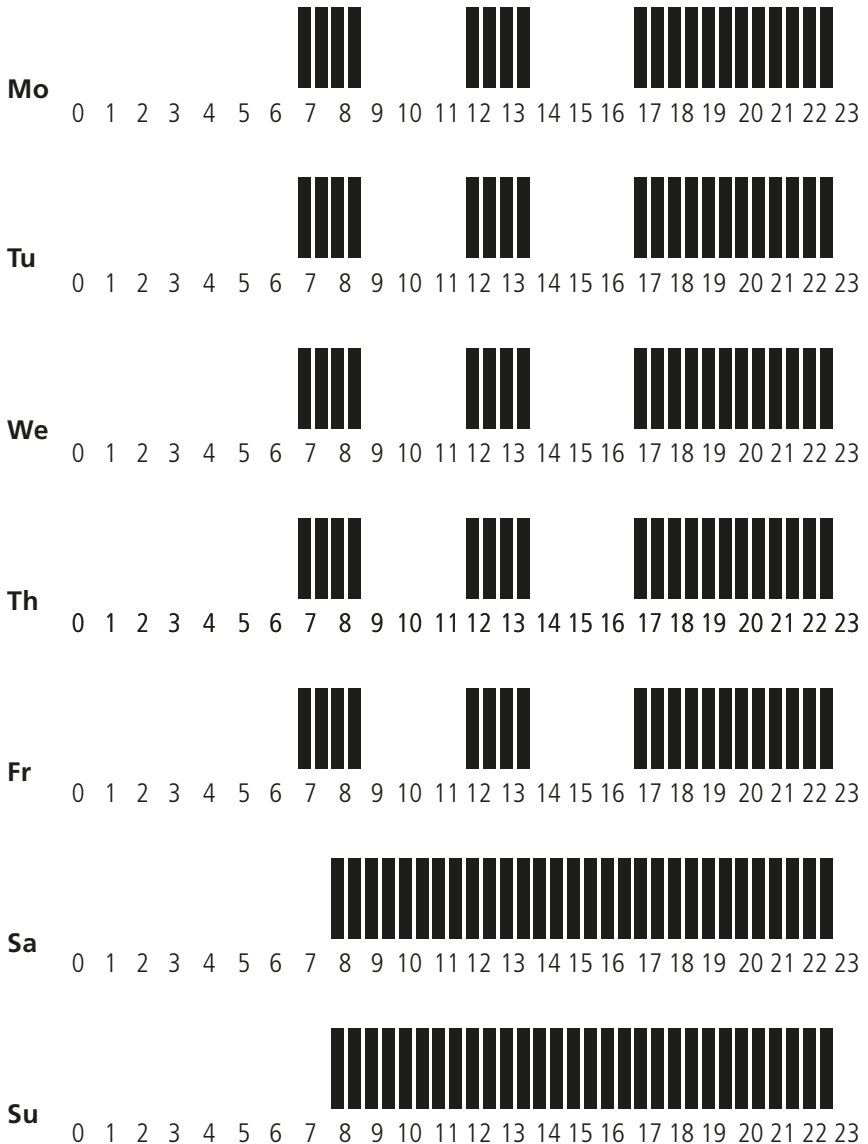

P3 Day & Weekend

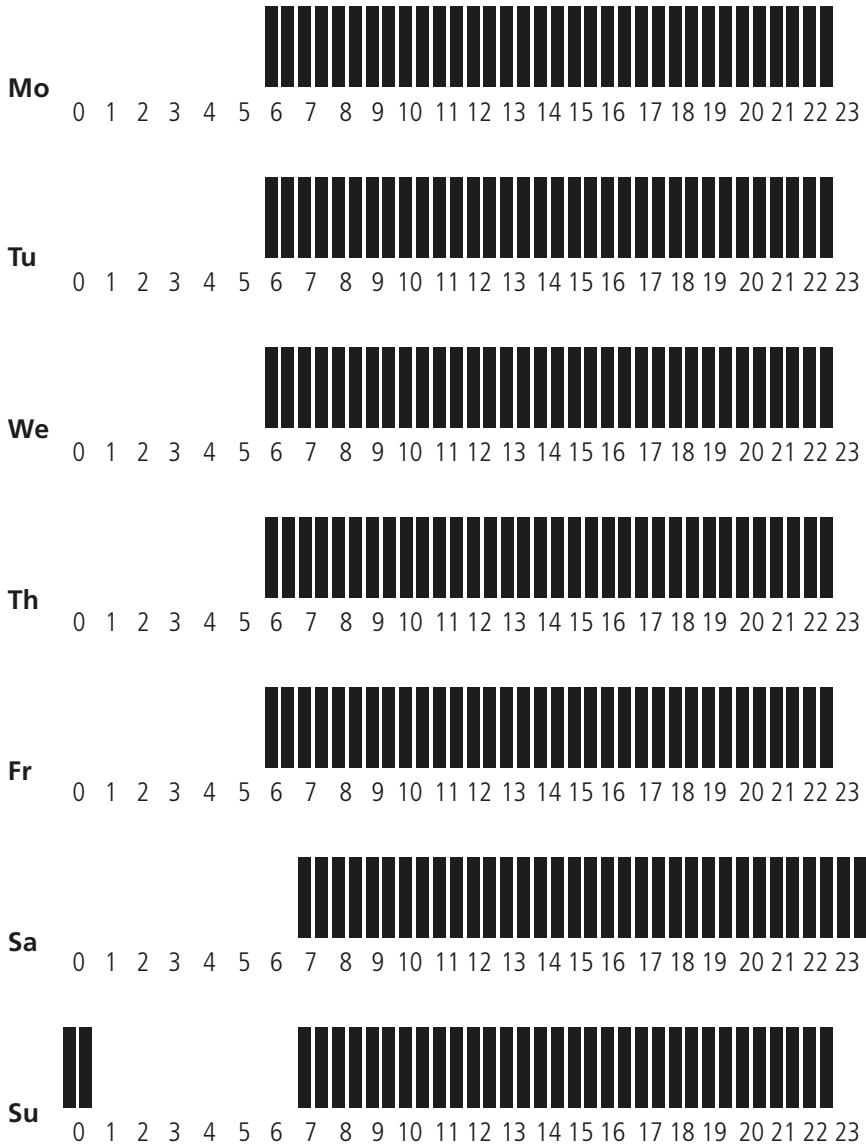

P4 Evening & Weekend

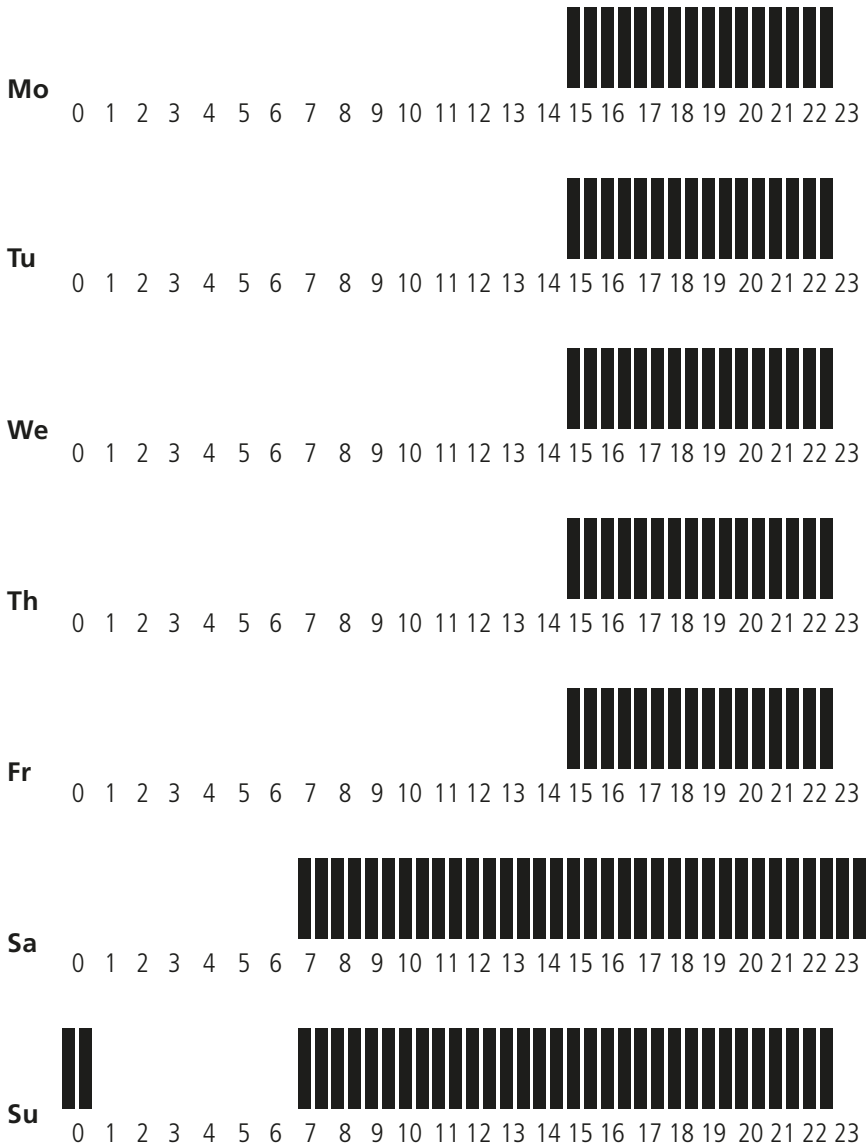

P5 Morning, Evening (Bathroom)

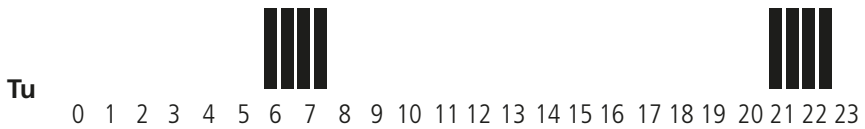

P6 Morning, Afternoon & Weekend



P7 7H - 19H (Office)



P8 8H - 19H & Saturday (Shop)



P9 Weekend (second house)

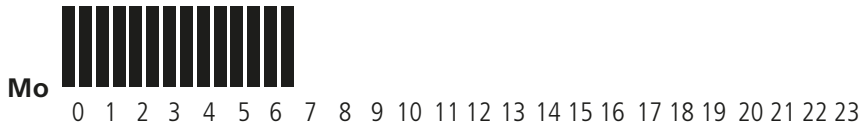

7 Hidden Menu:

There is a hidden menu which can be accessed by pressing and holding a combination of buttons.

The user menu can be used to set a number of user preference such as a 12 hour or 24 hour clock display, temperature readings in either degC or degF, etc and the installer menu can be used to adjust various operational settings of the unit.

To access the hidden menu set the unit to the **(Off)** mode and press and hold the **(OK)** button for 5 seconds.

UFHTIME2B User Menu

Menu No	Display	Description	Default	Option
00	INIt ZonE	Sets number of required channels	All zones are activated	1 to 2 zones
01	dEG	Temperature Display	Deg C	Deg F
02	Time	Clock Display	24H	12H
03	dSt	Automated clock change for Daylight Saving time	Yes	No
04	AirS	Current room temperature	N/A	None
05	AirC	Calibration of temperature reading	no	Displays Temp
06	SEnS	Remote room temperature ("Err": sensor not connected)	N/A	None
07	SEnC	Calibration of remote sensor temperature reading	no	Displays Temp
08	HG	Holiday mode frost setting	5.0°C	0.5°C to 10.0°C

UFHTIME2B User Menu

Menu No	Display	Description	Default	Option
09	CLr ALL	Restore factory Default settings		Press (OK) during 5s
10		Software Version		None
11	End	Return to main screen		Press (OK)

8 Technical Specification

Measured Temperature Precision:	0.1°C
Environmental Operating Temperature: Shipping and Storage Temperature:	0°C - 40°C -10°C to +50°C
Setting Temperature Range Anti freeze/OFF:	0.5°C to 10°C by 0.5° step
Regulation Characteristics:	Hysteresis of 0.5°C
Electrical Protection:	Class II - IP30
Power Supply: Operarting Life:	2 AAA LR03 1.5V Alkaline 2 years
Output:	2 Points Contact (Free Contact) Relay 5 Amps 250Vac
Optional External Sensor:	10k ohms at 25°C

9 Fault Diagnostics

My time clock doesn't start	
Battery Problem:	<ul style="list-style-type: none"> - Check if the protection sticker on the batteries is removed. - Check the orientation of the batteries. - Check the charge of the batteries
My time clock displays an error when backlight is off	
Problem on sensors	<p>“Err tEmP Air” (ambient sensor) : contact your installer</p> <p>“Err tEmP SEn” (remote sensor)</p> <ul style="list-style-type: none"> - Check the connection of the sensor - Disconnect the sensor and check it with an ohmmeter (the value must be around 10 kohms) - Remove the batteries to remove the error
Problem on keyboard	If the “Err Key” message remains after the period of displaying “Wait” please contact your installer
Battery level is low	The logo blinks (batteries) : replace the batteries
No active zone	“Error Zone” : activate at least one zone (paragraph 7)
My time clock seems work correctly but the temperature in the room was never in accordance with the program	
Program	<ul style="list-style-type: none"> - Check the clock. - Check the difference between Comfort and Setback temperature is not too high? - Contact your installer, to check and adjust the calibration.

Polypipe Building Products

Broomhouse Lane
Edlington
Doncaster DN12 1ES
Tel: 01709 770 000
Fax: 01709 770 001

2410 London Road
Mount Vernon
Glasgow G32 8XZ
Tel: 0141 778 8822
Fax: 0141 778 2703

Dromore Road
Lurgan, Craigavon
Co. Armagh BT66 7HL
Tel: 028 38 881270
Fax: 028 38 882344

www.polypipe.com

For technical advice visit www.polypipeufh.com

www.polypipe.com



Polypipe Building Products is a registered training division of Polypipe Limited