

JG Speedfit®
UNDERFLOOR

aura
heating controls



230v Dial Thermostat Instruction Manual

*For model:
JGSTAT1*



speedfitUFH.co.uk

Contents

Box contents:



Instruction Manual



Fixing screws



JGSTAT1

Instruction manual:

- Box contents
- Introduction
- Product compliance
- Safety information
- Mounting position and installation
- System grouping and communication
- User interface
- LED indication

Icons used in this manual:



Safety



Important info



Your benefit

For latest PDF Instruction Manual please go to speedfitUFH.co.uk

Product Compliance & Safety Information

Introduction. Thank you for purchasing the Speedfit Aura Dial Thermostat JGSTAT1. This is a 230v Dial Thermostat which offers simple temperature control of your heating system.

Speedfit recommends that you use your JGSTAT1 with the Aura JGWC Wiring Centre and JGSTAT2 Digital Room Thermostat. The JGSTAT2 can be used as a group control thermostat to control groups of STAT1s. Please see pages 6 and 7.



Product Compliance. This product is CE compliant and meets the following Directives:
EMC 2014/30/EU, LVD 2014/35/EU
and RoHS 2011/65/EU.

Declaration of conformity available
at saluslegal.com



Safety Information. Use in accordance with the regulations. The Aura JGSTAT1 is to be used for room control of hot water heating systems inside buildings.



Installation. This product must be fitted by a competent person, and installation must comply with the guidance, standards and regulations applicable to the location where the product is installed. Failure to comply with the requirements of the relevant guidance, standards and regulations could lead to injury, death or prosecution.



Always isolate the AC mains supply before installing or working on any components that require 230v AC 50Hz supply.

We hope you enjoy this product...

Product Compliance & Safety Information

These instructions are applicable to the Speedfit Aura model stated on the front cover of this Instruction Manual only.



Sources of danger. The thermostat must be disconnected from mains supply before removing the cover.



Emergency. Switch off the voltage to the individual thermostat wiring centre or complete system.



230v AC



Installer parameter settings. The Aura JGSTAT1 is equipped with Installer Parameters (see page 13).



For the installer. Please enter any parameter changes in the Installer Notes section.

Installation - Thermostat Mounting



Mounting position and installation. To ensure trouble free operation and efficient control, the unit is best positioned in a draft free area and at 130cm from the floor. Do not position the thermostat near any heat source, behind curtains, direct sunlight or an area of high humidity.

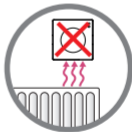
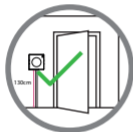

Not to be positioned on an exterior wall.

System Overview - Grouping and Communication



Power and Switching Cable - used to power thermostats and drive output.



Grouping and Communication cable.



While the thermostats can function as standalone, installing this optional inexpensive communication cable allows the thermostats to communicate with the Aura JGSTAT2 configured as a group control thermostat and used with the Aura JGWC Wiring Centre (both sold separately).



The JGSTAT1 will follow instructions from the JGSTAT2 bringing central control of features such as Time Control, Holiday and Party functions as well as Frost Control. The JGSTAT1 can leave or re-enter group control at the slide of a switch.



JGSTAT2 Group Control Thermostat (sold separately).

System Overview - Grouping and Communication

The maximum number of groups per JGWC Wiring Centre is two. The group selection communication cable must correspond to the group terminals on the JGWC. Please refer to the JGWC Wiring Centre Instruction Manual.



Group 1 - For example, downstairs



Group 2 - For example, upstairs



Aura JGWC Wiring Centre

Installation - Thermostat Mounting



Carefully remove the front housing.



i **Wall Mounting.** For wall mounting, mark and mount the rear case to the wall. The JGSTAT1 is suitable for wall boxes with a centre hole distance of:

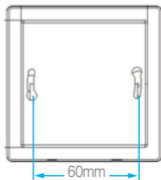

Installation - Terminal Connections

Understanding your terminal connections.

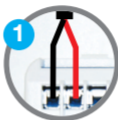
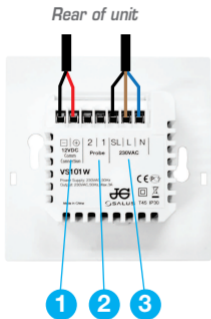

Communication Terminals 12v DC. Two wire twisted pair can be used for grouping functions between JGSTAT2 and JGSTAT1. Also required for Heat/Cool changeover.



Sensor Terminals. Can be used for external Air or Floor sensor.



Power Terminals 230v AC. Used for supplying power to the unit and switched output.

Installation - Thermostat Connections

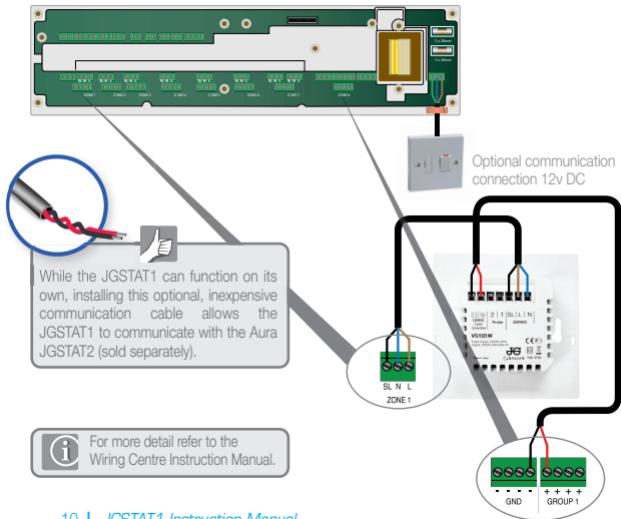

Installation - Terminal Connections



Check that the wiring is completed for:

- 1 Power terminals.
- 2 Sensor terminals (if applicable).
- 3 Communication connections (optional but recommended).



You are ready to secure the rear housing to the wall box.



Please use the screws provided.



Ensure the orientation arrow is pointing upwards.



Installation - Thermostat Mounting

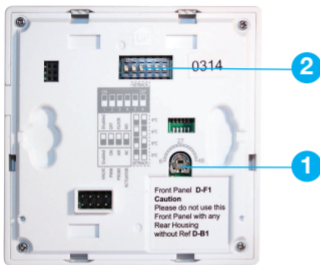

Fit the front housing to the rear housing as shown above.



1 **2** If any parameter settings need to be changed please refer to next page.

Installation - Parameter Setting

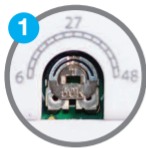

External sensor (optional)

If you are fitting an external sensor for air/floor sensing please select temp here. It can be set from 0°C - 45°C and is preset at 27°C. Please note the dip switches **2** need to be set for the correct external sensor type, see below.

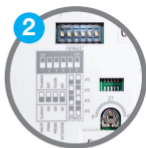

FUNCTION	DESCRIPTION	DEFAULT
Valve Exercising	If the installer setting is to enable the valve exercising the dial thermostat will additionally send 5 minute pulse on actuator once a week.	ENABLE
PWM	PWM output to drive actuator open/close (prevents temperature overshoot).	ON
External sensor type	Air or floor.	AIR
Actuator type	Normally Closed or Normally Open. JG Actuators are supplied ready for the default 'NC' setting	NC
Reduced temp offset / Night setback	0, 4, 6 or 8 (only when used with JGSTAT2 and JGWC).	4°C

User Interface

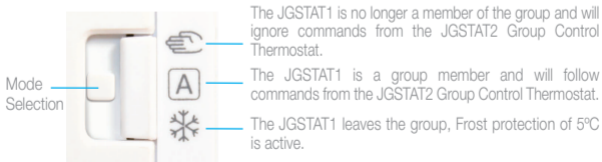
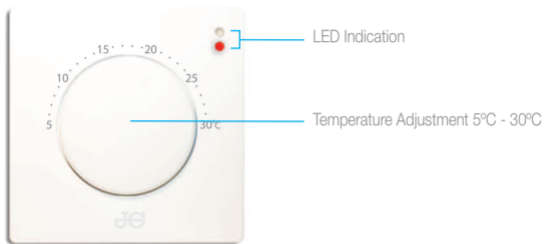

LED Indication - Group Member

Slide switch must be in **A** position to follow Group Control Thermostat JGSTAT2, see page 14.



RED LED indicates that power is going to the thermostat in normal operation. The top LED will illuminate when room temperature falls below your required temperature.



Green LED means that the thermostat is calling for heat. The Group Control Thermostat will be in one of the following modes:

- 1.
- 2.
- 3.

JGSTAT2 Group Control Thermostat display.



For more details on JGSTAT2 please refer to JGSTAT2 Instruction Manual.



If you do not want a JGSTAT1 to follow the Group Control Thermostat JGSTAT2. Please select or . See previous page.

LED Indication - Group Member

Slide switch must be in **A** position to follow Group Control Thermostat JGSTAT2, see page 14.



To reduce annoyance factor, no LED is shown when the Group Control Thermostat is in reduced temperature/night setback mode. See below.

To adjust reduced temperature offset please refer to page 13.



Amber LED means that the thermostat is calling for heat in reduced/night setback mode. The Group Control Thermostat will be in one of the following modes:

1. **A**
2. **A**

JGSTAT2 Group Control Thermostat display.



For more details on JGSTAT2 please refer to JGSTAT2 Instruction Manual.



If you do not want a JGSTAT1 to follow the Group Control Thermostat JGSTAT2. Please select or . See page 14.

LED Indication - Group Member

Slide switch must be in **A** position to follow Group Control Thermostat JGSTAT2, see page 14.



Blue LED indicates the thermostat is in Frost Protection Mode. Frost Protection temperature is fixed at 5°C.



Green LED means that the temperature has fallen below the frost protection level and the thermostat is calling for heat. The Group Control Thermostat will be in one of the following modes:

-
-

JGSTAT2 Group Control Thermostat display.



For more details on JGSTAT2 please refer to JGSTAT2 Instruction Manual.



If you do not want a JGSTAT1 to follow the Group Control Thermostat JGSTAT2. Please select or . See page 14.

LED Indication - Manual Mode

To enter Manual Mode, slide the switch to the  position. The thermostat will not follow the Group Control Thermostat JGSTAT2 and will no longer be part of the group. The JGSTAT1 will work as a stand alone thermostat.



RED Led indicates that power is going to the unit in normal operation. The top LED will illuminate when room temperature falls below your required temp.



Green LED means that the unit is calling for heat.



To return the JGSTAT1 to the group (if applicable) move the slide switch to

A

LED Indication - Permanent Frost Mode

To enter Manual Mode, slide the switch to the ❄️ position. The thermostat will not follow the group control thermostat JGSTAT2 and will no longer be part of the group. The JGSTAT1 will be in permanent Frost Protection.



Blue LED indicates the thermostat is in frost protection mode. Frost protection temperature is fixed at 5°C.



Green LED indicates the temperature has fallen below the Frost protection level and the thermostat is calling for heat.



To return the JGSTAT1 to the group (if applicable) move the slide switch to



Installation - Technical Detail

MODEL	JGSTAT1
TYPE	Wired Dial Thermostat designed for 230v AC heating/cooling applications
TEMPERATURE	
Scale	Celsius
Tolerance	0.5°C
Set Temperature range	5°C - 30°C
Frost Protection	5°C
CONTROL	ON-OFF control / PWM control
ENVIRONMENT RATINGS	
Operating Temperature	0°C to + 50°C
Storage Temperature	-20°C to + 60°C
Operating Humidity (non condensed)	5-95%RH
POWER SOURCE	230v AC 50Hz
CONTROL SWITCH AND RATING	
Loading	Maximum 3A at SL terminal
Input	Comm Connection 12v DC

John Guest Speedfit Limited

Horton Road, West Drayton, Middlesex UB7 8JL, England.

Tel: 01895 449233

Fax: 01895 420321

speedfitUFH.co.uk

Technical Help Desk: 01895 425333

 **John Guest**[®] and *Speedfit*[®]

The above namestyles are all trademarks of John Guest International Limited.

© **John Guest International Limited 2017. All rights reserved.**

Z2105/423/0117